

# > QCL

## Ventilatori assiali a telaio quadro compatti e ad alta efficienza

Compact and high efficiency axial fans



Conformi alla Direttiva ErP  
e al Regolamento UE327/2011 (FAN)

Categoria di misura: C  
Categoria di efficienza: Statica  
In conformità a EN ISO 5801 / AMCA 210.

Compliant with Erp Directive  
and EU Regulation 327/2011 (FAN)

Measurement category: C  
Efficiency category: Static  
According to EN ISO 5801 / AMCA 210.

### DESCRIZIONE GENERALE

I ventilatori della serie QCL sono adatti per la ventilazione, con fissaggio a parete nelle più svariate applicazioni civili, industriali e commerciali in cui siano richiesti ingombri limitati o prestazioni regolabili. La serie è costituita da 10 modelli con diametro girante da 200 a 710 mm. L'impiego è previsto con aria pulita nell'intervallo di temperatura da -25°C a +60°C. Il boccheggio ottimizzato ed il profilo bionico delle pale riducono il rumore e aumentano l'efficienza aeraulica ed energetica nel rispetto del Regolamento UE 327/2011.

### COSTRUZIONE

- Telaio portante in lamiera d'acciaio zincata stampato e imbutito, con raggio in aspirazione. Modelli 63 e 71 telaio portante in lamiera d'acciaio stampato e imbutito verniciato a polveri epossipoliestiriche.
- Girante elicoidale con pale a falce con sezione speciale stampate in tecnopolimero (200-400) o fusione di lega d'alluminio (450-710) direttamente calettato al rotore del motore.
- Esecuzione 5 (accoppiamento diretto con girante). Flusso dell'aria da motore a girante.
- Rete di protezione lato motore in tondino d'acciaio trafilato e protetto dalla corrosione. Modelli 200,250,630 e710 con funzione protezione e porta-motore. Realizzata a norme EN ISO 12499. Modelli 310-560 staffa supporto motore in acciaio verniciato a polveri epossidiche.
- Motore a rotore esterno, con termoprotettore, idoneo alla regolazione, trifase a doppia velocità (stella- triangolo YΔ) o monofase.
- Configurazione standard "quasi macchina" secondo direttiva 2006/42/CE

### A RICHIESTA

- Versione a flusso inverso.

### ACCESSORI

- Serranda a gravità (S).
- Distanziatore realizzato in lamiera verniciata a polveri epossipoliestiriche (D).
- Rete di protezione lato girante, realizzata a norme UNI EN ISO 12499 e protetta contro gli agenti atmosferici (R).

### GENERAL DESCRIPTION

The fans of the QCL series are suitable for the ventilation, with wall or panel, in residential, commercial and industrial buildings, where reduced dimensions or adjustable performances are required. The series consists of 10 models with impeller diameter from 200 to 710 mm. They are designed for clean air in the temperature range -25°C / +60°C.

The optimized inlet cone along with the bionic profile of the blades reduce noise level and increase the aeraulic and energetic efficiency according to the regulation EU 327/2011.

### CONSTRUCTION

- Supporting frame in drawn galvanized steel sheet, with radius inlet cone. Models 63 and 71 supporting frame in drawn steel sheet, with radius inlet cone, epoxy coated.
- Helical impeller with sickle-shaped on bionic finding blades in technopolymer (200-400) or die-cast aluminium alloy (450-710) directly united to the motor rotor.
- Execution 5 (impeller directly coupled to motor shaft). Air flow from motor to impeller.
- Inlet protection guard in steel rod, according to EN ISO 12499. Models 200,250,630 and 710 with protection function and motor support. Models 310-560 with motor support bracket in steel powder coated epoxy.
- External rotor motor, with built in thermal protection, suitable for adjustable, three-phase double speed (delta-star YΔ) or single-phase.
- Standard configuration "partly completed machinery" according to Directive 2006/42/EC.

### UPON REQUEST

- Reverse airflow version.

### ACCESSORIES

- Gravity shutter (S).
- Spacer manufactured in epoxy painted steel sheet (D).
- Impeller side protection guard manufactured according to UNI ISO 12499 rules and protected against atmospheric agents (R).

Le prestazioni aeruliche sono rilevate in conformit  alla norma EN ISO 5801/AMCA 210 con densit  dell'aria standard avente peso specifico 1.2 Kg/m<sup>3</sup>.  
Conformi alla Direttiva ErP 2009/125/CE e al regolamento UE327/2011.  
Categoria di misura: C. Categoria di efficienza: Statica.  
Alimentazione 230V/1Ph/50Hz o 400V/3Ph/50Hz.

Air performances measured according to EN ISO 5801 / AMCA 210 standard with air density with 1.2 kg/m<sup>3</sup> specific weight.  
Compliant with ErP 2009/125/EC Directive and EU Regulation 327/2011.  
Measurement category: C. Efficiency category: Static.  
Power supply 230V/1Ph/50Hz or 400V/3Ph/50Hz.

**Lp:** Livello di pressione sonora rilevato in condizioni di campo libero, propagazione emisferica, categoria di misura C a norma EN ISO 13349, nel punto di massimo rendimento, alla distanza di 3 metri dal lato aspirazione e si presenta solo per fini comparativi.  
**Lw:** Livello di potenza sonora ottenuto secondo norma ISO 3746. Tolleranza +/- 3 dB(A).

**Lp:** Sound pressure level measured in free field conditions, propagation hemispherical, measurement category C in accordance with EN ISO 13349, at the point of maximum efficiency at a distance of 3 meters, inlet side (for comparative purposes only).  
**Lw:** Sound power level obtained in accordance with EN ISO 3746. Tolerance +/- 3 dB(A).

## Versioni MONOFASE - SINGLE PHASE versions

QCL 200-250 / Monofase - Single phase								
Cod.	Tipo Type	Modello Model	U	P	Pm (kW)	In (A)	Capacit� (�F)	IP/CL
1CP2011	QCL	202	M	2	0,08	0,38	1,5	54/F
1CP2511	QCL	254	M	4	0,05	0,24	1,5	54/F

Livelli sonori - Sound levels / dB(A)									
[Hz]	63	125	250	500	1000	2000	4000	8000	TOT
QCL 202 Lw	38	41	50	52	58	61	58	51	65
QCL 202 Lp	20	24	32	35	41	44	40	34	48
QCL 254 Lw	27	44	43	51	52	53	50	41	58
QCL 254 Lp	9	26	25	33	34	35	32	23	40

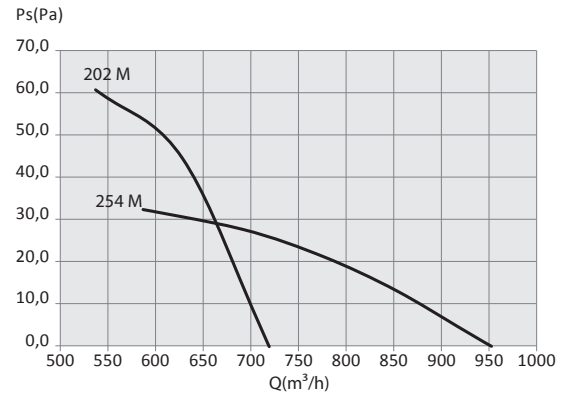

QCL 310-350 / Monofase - Single phase								
Cod.	Tipo Type	Modello Model	U	P	Pm (kW)	In (A)	Capacit� (�F)	IP/CL
1CP3011	QCL	314	M	4	0,10	0,42	3	54/F
1CP3511	QCL	354	M	4	0,12	0,56	5	54/F

Livelli sonori - Sound levels / dB(A)									
[Hz]	63	125	250	500	1000	2000	4000	8000	TOT
QCL 314 M Lw	27	47	49	51	54	59	55	43	62
QCL 314 M Lp	9	29	31	33	36	41	37	25	44
QCL 354 M Lw	33	54	50	54	58	60	55	45	64
QCL 354 M Lp	15	36	32	36	40	42	37	27	46

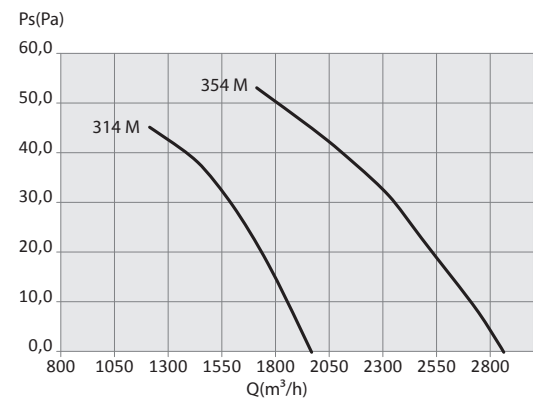

QCL 400-450-500 / Monofase - Single phase								
Cod.	Tipo Type	Modello Model	U	P	Pm (kW)	In (A)	Capacit� (�F)	IP/CL
1CP4017	QCL	404	M	4	0,24	1,05	5	54/F
1CP4519	QCL	454	M	4	0,60	2,90	7	44/F
1CP5017	QCL	504	M	4	0,72	3,20	16	54/F

Livelli sonori - Sound levels / dB(A)									
[Hz]	63	125	250	500	1000	2000	4000	8000	TOT
QCL 404 M Lw	36	57	60	61	64	64	59	48	69
QCL 404 M Lp	18	39	42	43	46	46	41	30	51
QCL 454 M Lw	36	60	62	69	67	68	68	59	75
QCL 454 M Lp	18	42	44	51	49	50	50	41	57
QCL 504 M Lw	40	60	60	64	67	69	64	55	73
QCL 504 M Lp	22	42	42	46	49	51	46	37	55

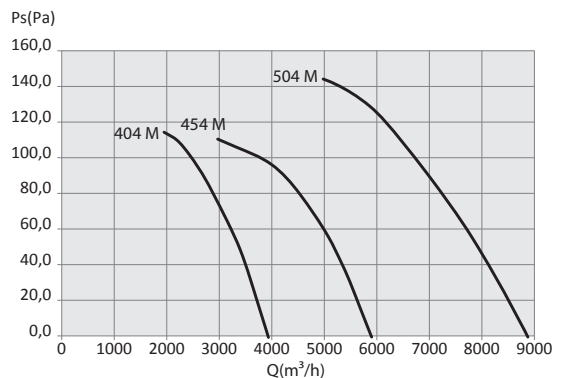

sez. 1.2

Le prestazioni aeruliche sono rilevate in conformità alla norma EN ISO 5801/AMCA 210 con densità dell'aria standard avente peso specifico 1.2 Kg/m<sup>3</sup>.  
 Conformi alla Direttiva ErP 2009/125/CE e al regolamento UE327/2011.  
 Categoria di misura: C. Categoria di efficienza: Statica.  
 Alimentazione 230V/1Ph/50Hz o 400V/3Ph/50Hz.

Air performances measured according to EN ISO 5801 / AMCA 210 standard with air density with 1.2 kg/m<sup>3</sup> specific weight.  
 Compliant with ErP 2009/125/EC Directive and EU Regulation 327/2011.  
 Measurement category: C. Efficiency category: Static.  
 Power supply 230V/1Ph/50Hz or 400V/3Ph/50Hz.

**Lp:** Livello di pressione sonora rilevato in condizioni di campo libero, propagazione emisferica, categoria di misura C a norma EN ISO 13349, nel punto di massimo rendimento, alla distanza di 3 metri dal lato aspirazione e si presenta solo per fini comparativi.  
**Lw:** Livello di potenza sonora ottenuto secondo norma ISO 3746. Tolleranza +/- 3 dB(A).

**Lp:** Sound pressure level measured in free field conditions, propagation hemispherical, measurement category C in accordance with EN ISO 13349, at the point of maximum efficiency at a distance of 3 meters, inlet side (for comparative purposes only).  
**Lw:** Sound power level obtained in accordance with EN ISO 3746. Tolerance +/- 3 dB(A).

## Versioni TRIFASE - THREE PHASE versions

### QCL 400 / Trifase - Three phase

Cod.	Tipo Type	Modello Model	U	P	Pm (kW)	In (A)	IP/CL
1CP4018	QCL	404	T	4	0,23/0,17	0,46/0,27	54/F

#### Livelli sonori - Sound levels / dB(A)

[Hz]	63	125	250	500	1000	2000	4000	8000	TOT
QCL 404 T LS Lw	35	51	51	57	60	60	55	45	65
QCL 404 T LS Lp	17	33	33	39	42	42	37	27	47
QCL 404 T HS Lw	36	54	55	60	64	64	59	49	69
QCL 404 T HS Lp	18	36	37	42	46	46	41	31	51

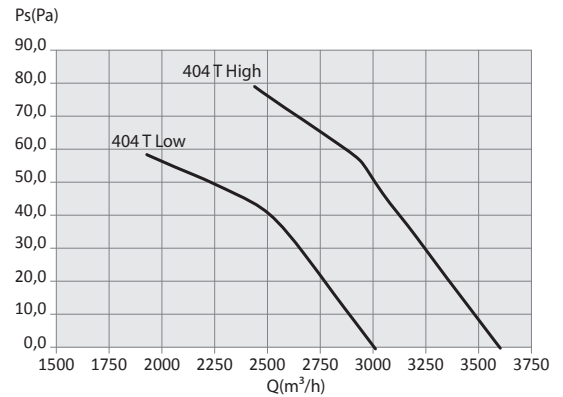

### QCL 450 / Trifase - Three phase

Cod.	Tipo Type	Modello Model	U	P	Pm (kW)	In (A)	IP/CL
1CP4520	QCL	454	T	4	0,54/0,36	1,10/0,66	44/F

#### Livelli sonori - Sound levels / dB(A)

[Hz]	63	125	250	500	1000	2000	4000	8000	TOT
QCL 454 T LS Lw	33	52	51	64	65	67	60	51	70
QCL 454 T LS Lp	15	34	33	46	47	49	42	33	52
QCL 454 T HS Lw	35	58	55	62	69	70	66	57	74
QCL 454 T HS Lp	17	40	37	44	51	52	48	39	56

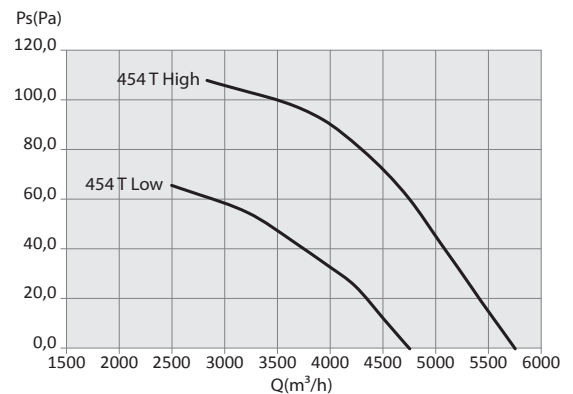

### QCL 500 / Trifase - Three phase

Cod.	Tipo Type	Modello Model	U	P	Pm (kW)	In (A)	IP/CL
1CP5018	QCL	504	T	4	0,84/0,54	1,45/0,96	54/F

#### Livelli sonori - Sound levels / dB(A)

[Hz]	63	125	250	500	1000	2000	4000	8000	TOT
QCL 504 T LS Lw	33	55	61	61	66	68	62	53	72
QCL 504 T LS Lp	15	37	43	43	48	50	44	35	54
QCL 504 T HS Lw	37	61	59	65	70	72	69	59	76
QCL 504 T HS Lp	19	43	41	47	52	54	51	41	58

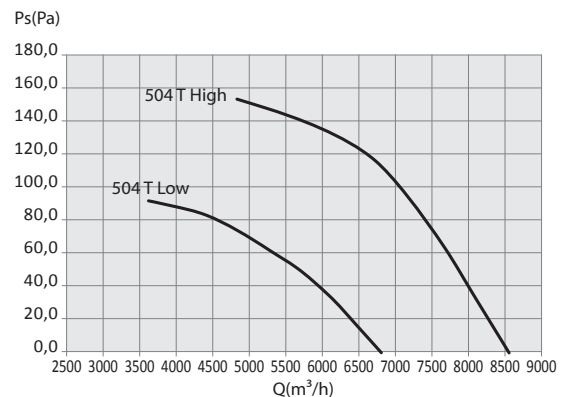

Le prestazioni aeruliche sono rilevate in conformità alla norma EN ISO 5801/AMCA 210 con densità dell'aria standard avente peso specifico 1.2 Kg/m<sup>3</sup>.  
 Conformi alla Direttiva ErP 2009/125/CE e al regolamento UE327/2011.  
 Categoria di misura: C. Categoria di efficienza: Statica.  
 Alimentazione 230V/1Ph/50Hz o 400V/3Ph/50Hz.

Air performances measured according to EN ISO 5801 / AMCA 210 standard with air density with 1.2 kg/m<sup>3</sup> specific weight.  
 Compliant with ErP 2009/125/EC Directive and EU Regulation 327/2011.  
 Measurement category: C. Efficiency category: Static.  
 Power supply 230V/1Ph/50Hz or 400V/3Ph/50Hz.

**Lp:** Livello di pressione sonora rilevato in condizioni di campo libero, propagazione emisferica, categoria di misura C a norma EN ISO 13349, nel punto di massimo rendimento, alla distanza di 3 metri dal lato aspirazione e si presenta solo per fini comparativi.  
**Lw:** Livello di potenza sonora ottenuto secondo norma ISO 3746. Tolleranza +/- 3 dB(A).

**Lp:** Sound pressure level measured in free field conditions, propagation hemispherical, measurement category C in accordance with EN ISO 13349, at the point of maximum efficiency at a distance of 3 meters, inlet side (for comparative purposes only).  
**Lw:** Sound power level obtained in accordance with EN ISO 3746. Tolerance +/- 3 dB(A).

## Versioni TRIFASE - THREE PHASE versions

### QCL 560 / Trifase - Three phase

Cod.	Tipo Type	Modello Model	U	P	Pm (kW)	In (A)	IP/CL
1CP5612	QCL	564	T	4	1,05/0,58	2,20/1,10	54/F

Livelli sonori - Sound levels / dB(A)									
[Hz]	63	125	250	500	1000	2000	4000	8000	TOT
QCL 564 T LS Lw	44	58	59	65	70	70	65	57	75
QCL 564 T LS Lp	26	40	41	47	52	52	47	39	57
QCL 564 T HS Lw	47	66	65	71	75	75	72	63	80
QCL 564 T HS Lp	29	48	47	53	57	57	54	45	62

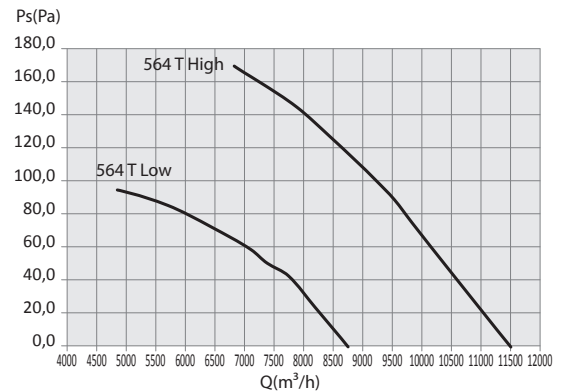

sez. 1.2

### QCL 630 / Trifase - Three phase

Cod.	Tipo Type	Modello Model	U	P	Pm (kW)	In (A)	IP/CL
1CP6312	QCL	636	T	6	0,62/0,44	1,25/0,72	54/F

Livelli sonori - Sound levels / dB(A)									
[Hz]	63	125	250	500	1000	2000	4000	8000	TOT
QCL 636 T LS Lw	33	45	52	57	64	64	57	48	68
QCL 636 T LS Lp	15	27	34	39	46	46	39	30	50
QCL 636 T HS Lw	34	55	56	60	66	67	61	52	71
QCL 636 T HS Lp	16	37	38	42	48	49	43	34	53

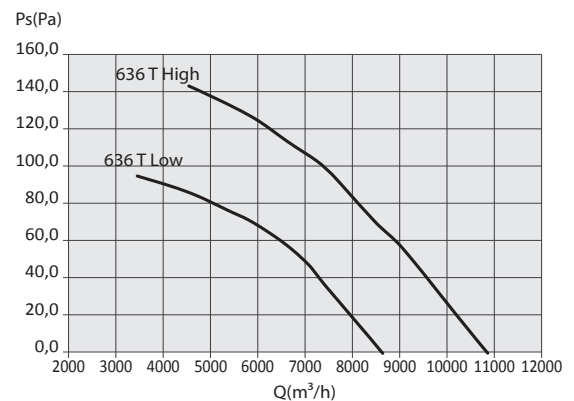

### QCL 710 / Trifase - Three phase

Cod.	Tipo Type	Modello Model	U	P	Pm (kW)	In (A)	IP/CL
1CP7013	QCL	716	T	6	0,94/0,64	1,75/1,10	54/F

Livelli sonori - Sound levels / dB(A)									
[Hz]	63	125	250	500	1000	2000	4000	8000	TOT
QCL 716 T LS Lw	36	52	54	58	63	64	57	48	68
QCL 716 T LS Lp	18	34	36	40	45	46	39	30	50
QCL 716 T HS Lw	34	53	58	61	66	66	62	52	71
QCL 716 T HS Lp	16	35	40	43	48	48	44	34	53

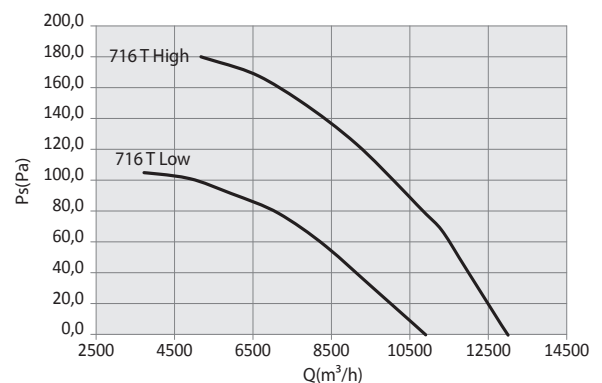

sez.  
**1.2**

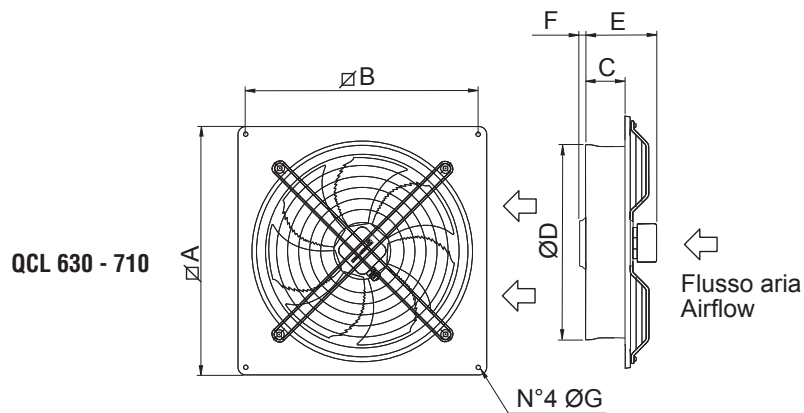
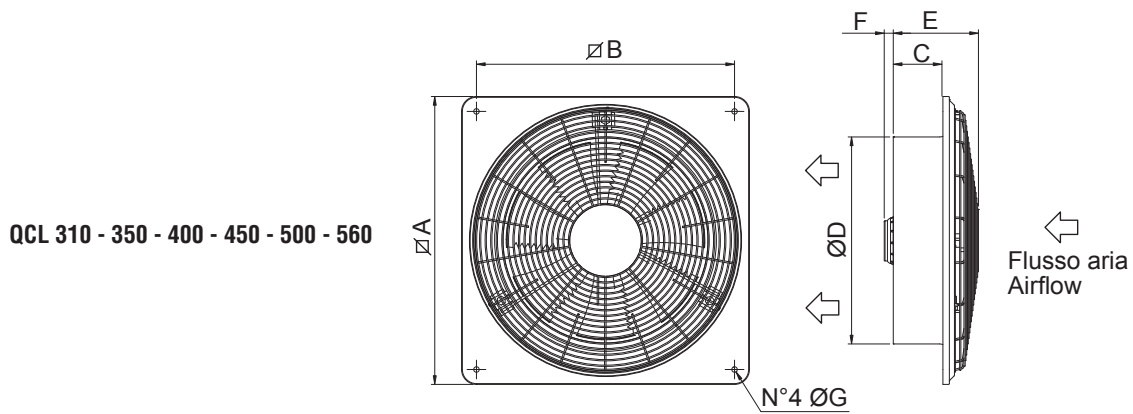
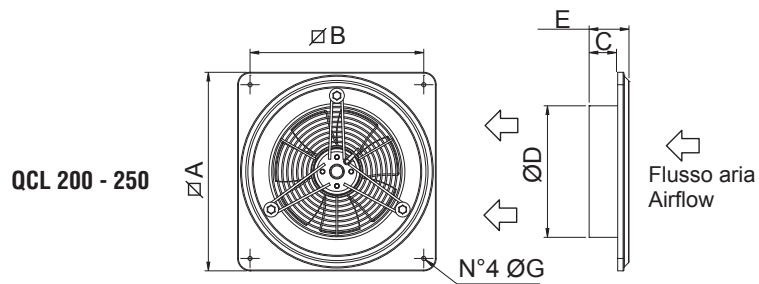

TIPO / TYPE	A	B	C	$\varnothing D$	E	F	G	Kg*
QCL 200	345	305	44	215	76	-	8,5	2,6
QCL 250	400	350	57	265	80	-	8,5	3,2
QCL 310	465	405	77	312	151	-	10	4,5
QCL 350	525	465	90	365	167	-	10	6
QCL 400	580	520	100	413	172	-	10	9
QCL 450	630	570	107	457	210	33	10	15
QCL 500	700	640	137	512	239	23	10	17,5
QCL 560	765	695	122	569	217	42	10	22,5
QCL 630	800	730	135	650	210	20	11	24,5
QCL 710	850	800	95	730	180	20	11	31,5

Dimensioni in mm / *Dimensions in mm*

\*Pesi indicativi / *Indicative weights*

**SERRANDA A GRAVITÀ - GRAVITY SHUTTER (S)**

Evita dispersioni di calore e l'entrata del vento, pioggia o volatili. Le alette della serranda si aprono con il movimento dell'aria a ventilatore in funzione, richiudendosi per gravità al suo spegnimento. Il telaio è in acciaio verniciato a polveri epossipoliestiriche e le alette sono in tecnopolimero. Resistenza trascurabile al passaggio dell'aria.

*It avoids heat loss and entry of wind, rain and birds. The fins of the shutter are opened by the air flow when the fan is working and they close down by gravity when the fan is switched off. The frame is in steel sheet painted with epoxy powder coating and the fins are in techno-polymer. Negligible losses of air flow.*

Cod.	TIPO TYPE	A	B	C	ØD	PESO (kg)
1SE2000	S 20	275	250	10	10	1.0
1SE2500	S 25	325	300	10	10	1.5
1SE3000	S 31	375	350	10	10	2.0
1SE3500	S 35	425	400	10	10	2.5
1SE4000	S 40	475	450	10	10	3.0
1SE4500	S 45	530	500	15	10	3.5
1SE5000	S 50	630	600	15	10	4.0
1SE5600	S 56	660	630	15	10	4.5
1SE6300	S 63	760	730	15	10	5.5
1SE7000	S 71	830	800	15	10	6.0

Dimensioni in mm / Dimensions in mm

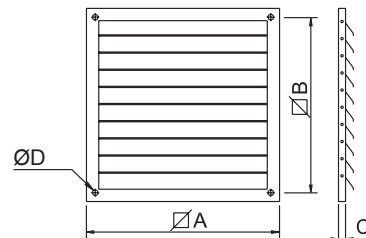

**DISTANZIATORE - SPACER (D)**

Serve, principalmente, a supportare il ventilatore quando la parete ha uno spessore inferiore all'altezza del boccaglio del ventilatore stesso. Il telaio è in lamiera zincata (D63 - D71 sono verniciate a polveri epossipoliestiriche), ai quattro angoli sono previsti inserti filettati in acciaio zincato per il fissaggio del pannello del ventilatore, su di un lato e della serranda e/o della rete sull'altro lato.

*It is needed to support the fan when the width of the wall is smaller than the dimension "C" (height of the fan inlet cone). Frame is in galvanized steel sheet (D63 and D71 are painted with epoxy powder coating); on the four corners there are 8 threaded inserts in galvanized steel sheet, for fixing the fan in one side and the shutter and/ or the grid on the other side.*

Cod.	TIPO TYPE	A	B	C	D	E	F	G	PESO (kg)
1DP2002	D 20	340	305	250	230	70	280	M6	1,8
1DP2502	D 25	390	350	300	280	70	330	M6	2,2
1DP3002	D 30	445	405	350	330	100	380	M6	3,0
1DP3502	D 35	510	465	400	380	100	430	M6	3,4
1DP4003	D 40	560	520	450	420	120	480	M6	4,6
1DP4502	D 45	610	570	500	470	120	530	M6	5,0
1DP5003	D 50	680	640	600	570	150	630	M8	5,4
1DP5602	D 56	750	695	630	605	150	685	M8	6,6

Dimensioni in mm / Dimensions in mm

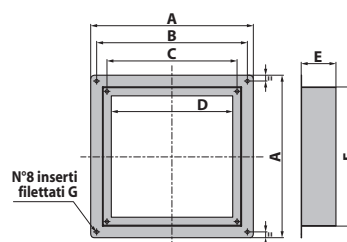

Cod.	TIPO TYPE	A	B	E	G	PESO (kg)
1DP6301	D 63	790	729	210	M8	9,8
1DP7000	D 71	840	800	115	M8	6,5

Dimensioni in mm / Dimensions in mm

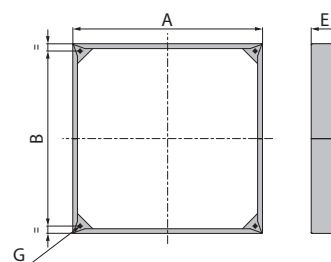

**RETE DI PROTEZIONE - PROTECTION GUARD (R)**

Evita il contatto accidentale con la girante del ventilatore. Il telaio e la rete sono in acciaio verniciato a polveri epossipoliestiriche.

*It avoids the accidental contact with the impeller of the fan. Frame and grid are in epoxy painted steel sheet.*

Cod.	TIPO TYPE	A	B	C	ØD	PESO (kg)
5RE7020	R 20	275	250	10	10	1.3
5RE7025	R 25	325	300	10	10	1.5
5RE7031	R 31	375	350	10	10	1.9
5RE7035	R 35	425	400	10	10	2.3
5RE7040	R 40	475	450	10	10	2.7
5RE7045	R 45	530	500	15	10	2.8
5RE7050	R 50	630	600	15	10	4.0
5RE7056	R 56	660	630	15	10	4.6
5RE7063	R 63	760	730	15	10	5.3
5RE7070	R 71	830	800	15	10	6.0

Dimensioni in mm / Dimensions in mm

